



Convention

Technical Specification

Casing material	Die-Cast Aluminium, Aluminium Sheet Rotating Cover
Cover	Super White Toughened Glass
Additional Features	Double Photometric Diffuser Technology, Sealed Lamp Housing
Ingress Protection	IP65
Colour Rendering	Ra >70
Working Temperature	-40°C - +55°C
Life Span	>50,000 hours
Power Factor	>0.95

Power	Lumen		
	WW	NW	CW
35W	3100lm	3200lm	3300lm
45W	3950lm	4000lm	4200lm
55W	4850lm	5000lm	5200lm
60W	5350lm	5500lm	5700lm



Type 1

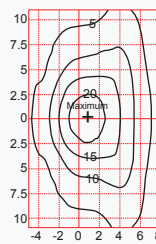
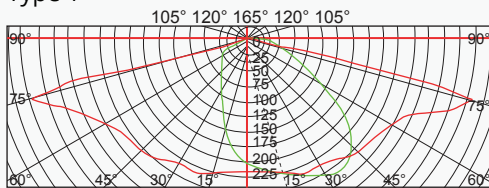

Type 2

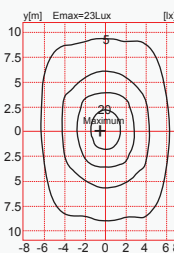
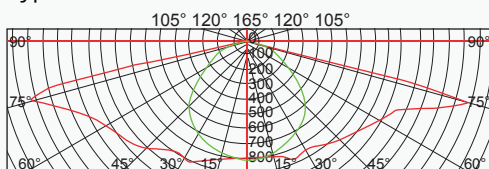

Type 3

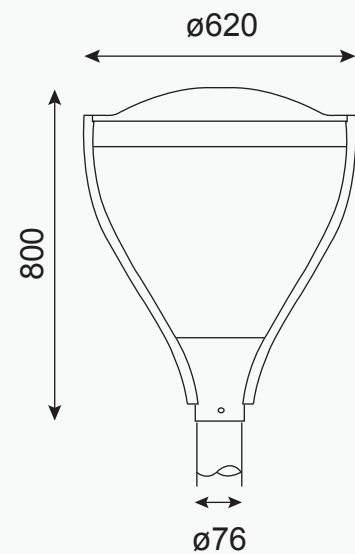
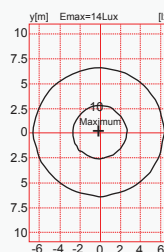
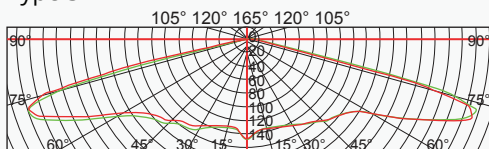

*all dimensions in mm