

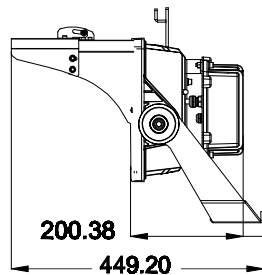

Challenger Pro Series

Technical Specification

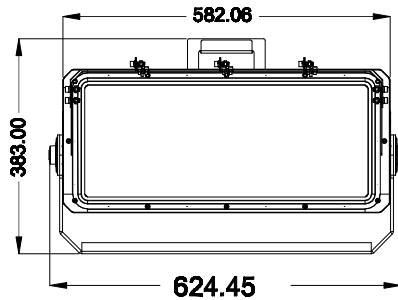

500W/600W

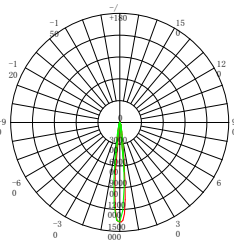

10°

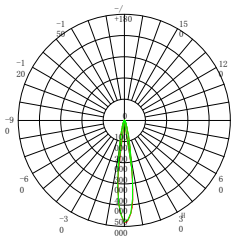

15°

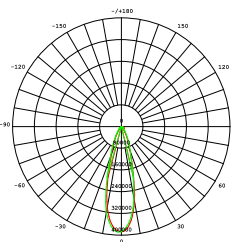

30°

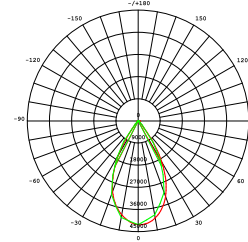

60°

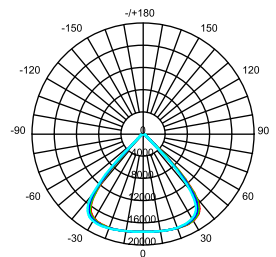

90°

LED

| Type: | Challenger Pro4 |
|---------------------|--|
| Wattages | 400W 500W 600W |
| Lumens | 150lm/W |
| CCT | 3000K - 6500K |
| Ingress Protection | IP66 & Water-proof |
| Impact Protection | IK10 |
| Weight | 38.0kg |
| Material | Die-Casting Aluminium |
| Installation Spigot | According to requirements in Lighting Design |



Challenger Pro Series

Technical Specification



Optional glare shield 15° adjustment.

Rotation of the lamp can be achieved by adjusting the screw on one side.

Attributes

Various Wattages available 400W, 500W, 600W, 800W, 1000W, 1200W, 1500W, 1800W to match various requirements.

Flexible Beam angle adjustment Gear Rotatable Design (User-friendly).

Unique optical design with no frequency and optional Anti-glare covers.

Modular assembly.

Beam angles: 10°, 15°, 30°, 60°, 90°. T2 for option.

Strong corrosion resistance powder coated finish, suitable for harsh outdoor environments.

Integrated 600W Driver box on each light module.